



Genie[®]
A TEREX BRAND

Operator's Manual

Serial Number Range

GR-12
GR-15
GR-20

from GR10-20000

CE

with
Maintenance
Information

Original Instructions
Sixth Edition
Third Printing
Part No. 133572



Important

Read, understand and obey these safety rules and operating instructions before operating this machine. Only trained and authorized personnel shall be permitted to operate this machine. This manual should be considered a permanent part of your machine and should remain with the machine at all times. If you have any questions, contact us.

Contact Us:

Internet: www.genielift.com

E-mail: awp.techpub@terex.com

Contents

Introduction	1
Symbol and Hazard Pictorials Definitions.....	3
General Safety	5
Personal Safety.....	7
Work Area Safety.....	8
Legend	15
Controls.....	16
Inspections.....	19
Operating Instructions.....	32
Transport and Lifting Instructions	41
Maintenance	45
Specifications.....	47

Copyright © 2000 Terex Corporation

Sixth Edition: Third Printing, October 2014

Genie is a registered trademark of Terex South Dakota, Inc. in the U.S.A. and many other countries. "GR" is a trademark of Terex South Dakota, Inc.

 Complies with EC Directive 2006/42/EC
See EC Declaration of Conformity



Introduction

Owners, Users and Operators:

Thank you for choosing our machine for your application. Our number one priority is user safety, which is best achieved by our joint efforts. We feel that you make a major contribution to safety if you, as the equipment users and operators:

- 1 **Comply** with employer, job site and governmental rules.
- 2 **Read, understand and follow** the instructions in this and other manuals supplied with this machine.
- 3 **Use good safe work practices** in a commonsense way.
- 4 **Only have trained/certified operators**, directed by informed and knowledgeable supervision, running the machine.



Danger

Failure to obey the instructions and safety rules in this manual will result in death or serious injury.

Do Not Operate Unless:

- You learn and practice the principles of safe machine operation contained in this operator's manual.
 - 1 **Avoid hazardous situations.**
 - Know and understand the safety rules before going on to the next section.**
 - 2 Always perform a pre-operation inspection.
 - 3 Always perform function tests prior to use.
 - 4 Inspect the workplace.
 - 5 Only use the machine as it was intended.
- You read, understand and obey the manufacturer's instructions and safety rules—safety and operator's manuals and machine decals.
- You read, understand and obey employer's safety rules and worksite regulations.
- You read, understand and obey all applicable governmental regulations.
- You are properly trained to safely operate the machine.



Introduction

Hazard Classification

Decals on this machine use symbols, color coding and signal words to identify the following:



Safety alert symbol—used to alert you to potential personal injury hazards. Obey all safety messages that follow this symbol to avoid possible injury or death.

▲ DANGER

Indicates a hazardous situation which, if not avoided, will result in death or serious injury.

▲ WARNING

Indicates a hazardous situation which, if not avoided, could result in death or serious injury.

▲ CAUTION

Indicates a hazardous situation which, if not avoided, could result in minor or moderate injury.

NOTICE

Indicates a property damage message.

Intended Use

This machine is intended to be used only to lift personnel, along with their tools and materials to an aerial work site.

Safety Sign Maintenance











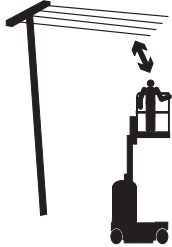

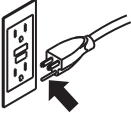

Replace any missing or damaged safety signs. Keep operator safety in mind at all times. Use mild soap and water to clean safety signs. Do not use solvent-based cleaners because they may damage the safety sign material.

Symbol and Hazard Pictorials Definitions

Read the operator's manual	Read the service manual	Crush hazard	No smoking	Collision hazard
Collision hazard	Tip-over hazard	Tip-over hazard	Use a piece of cardboard or paper to search for leaks	Electrocution hazard
Electrocution hazard	Explosion hazard	Fire hazard	Burn hazard	Skin injection hazard
Transport diagram	Tiedown	Keep away from moving parts	Move machine to level ground	Batteries used as counterweights

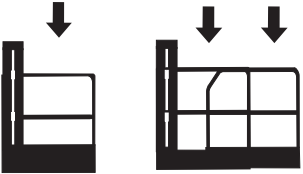

Symbol and Hazard Pictorials Definitions

 <p>Maintain required clearance</p>	 <p>Only trained maintenance personnel should access compartments</p>	 <p>Chock the wheels</p>	 <p>Release brakes</p>	 <p>Grounded AC 3-wire only</p>
 <p>Replace damaged wires and cords</p>	 <p>Wheel load</p>	 <p>Lanyard anchorage points</p>	 <p>Side force</p>	 <p>Wind speed</p>
 <p>Maximum capacity</p>		 <p>Voltage rating for power to platform</p>	 <p>Pressure rating for air line to platform</p>	 <p>Emergency lowering</p>
 <p>Maximum capacity including occupant, tools and tray</p>				

General Safety

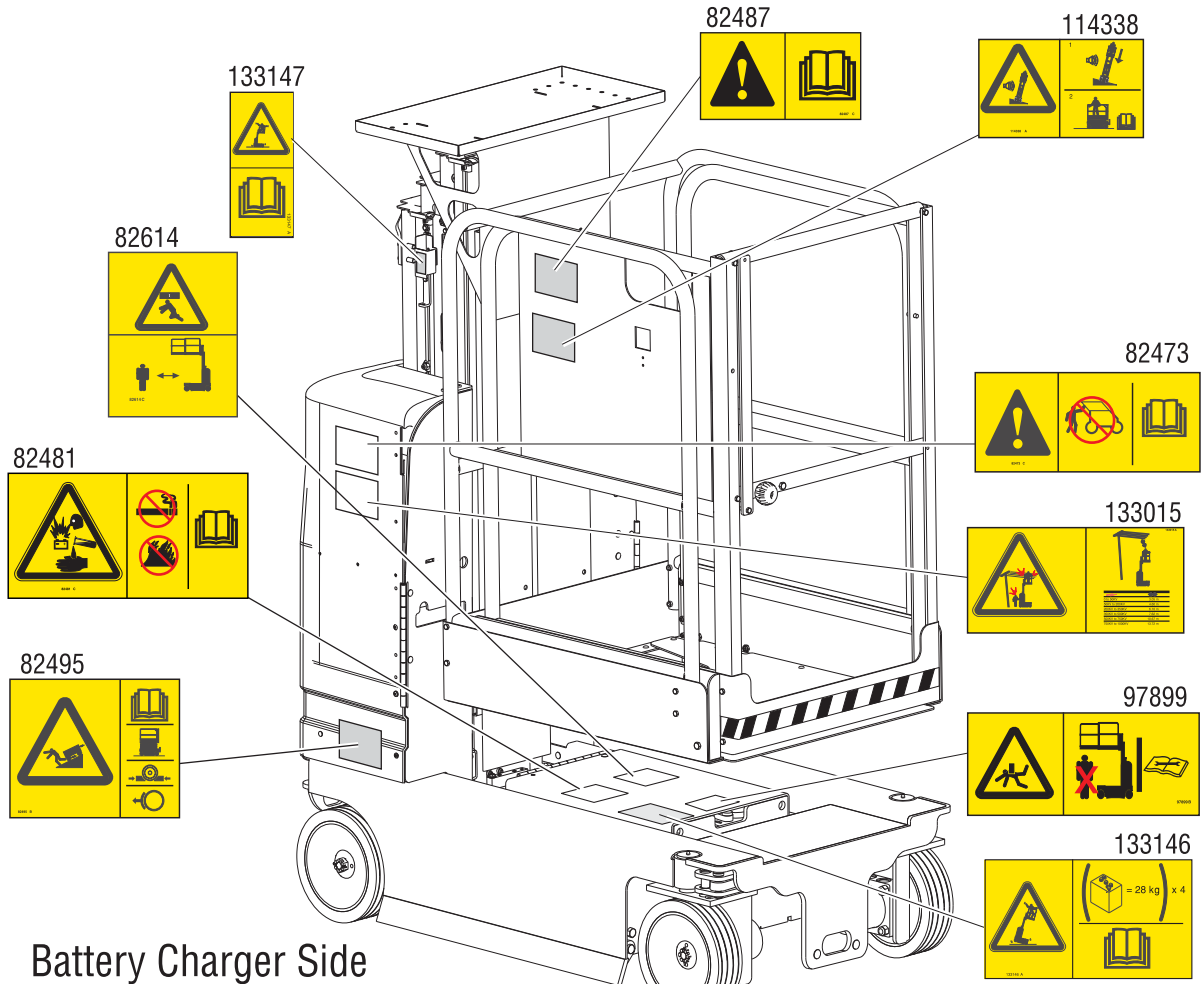

Battery Charger Side

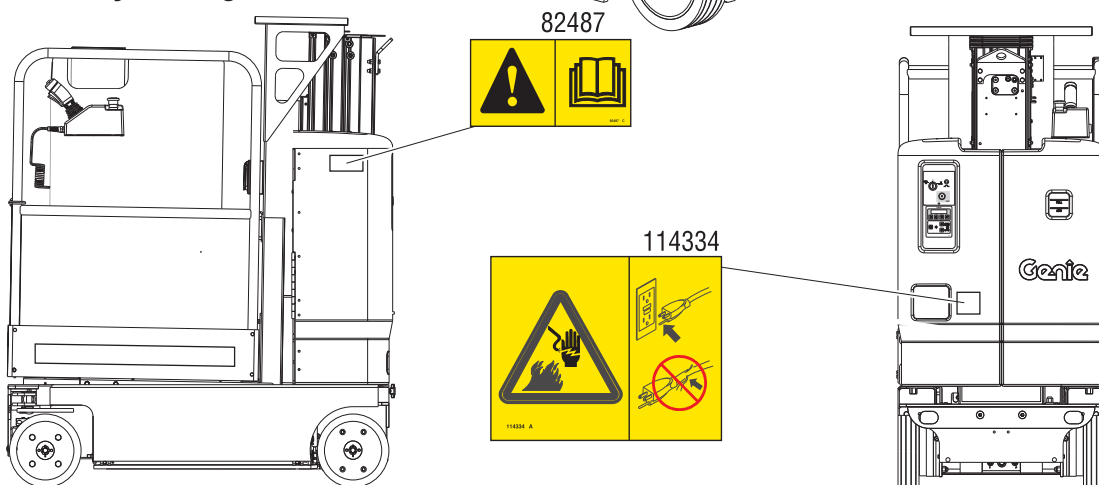

General Safety

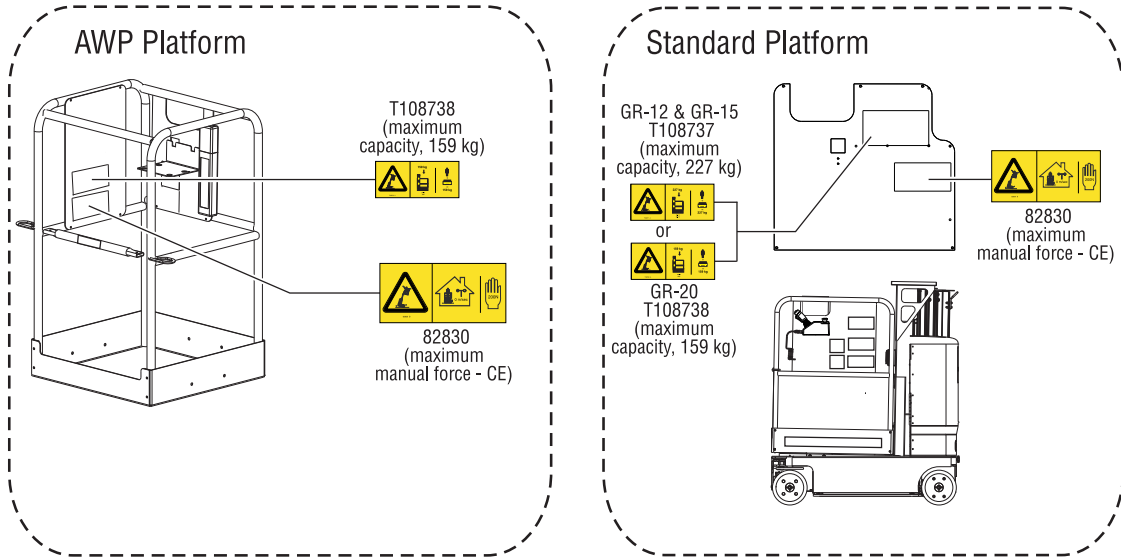



Personal Safety

Personal Fall Protection

Personal fall protection equipment (PFPE) is not required when operating this machine. If PFPE is required by job site or employer rules, the following shall apply:

All PFPE must comply with applicable governmental regulations and must be inspected and used in accordance with the manufacturer's instructions.

Work Area Safety

⚠ Electrocutation Hazards



This machine is not electrically insulated and will not provide protection from contact with or proximity to electrical current.



Maintain safe distances from electrical power lines and apparatus in accordance with applicable governmental regulations and the following chart.

Line Voltage	Required Clearance
0 to 50KV	3.05 m
50 to 200KV	4.60 m
200 to 350KV	6.10 m
350 to 500KV	7.62 m
500 to 750KV	10.67 m
750 to 1000KV	13.72 m

Allow for platform movement, electrical line sway or sag, and beware of strong or gusty winds.

Keep away from the machine if it contacts energized power lines. Personnel on the ground or in the platform must not touch or operate the machine until energized power lines are shut off.

Do not operate the machine during lightning or storms.

Do not use the machine as a ground for welding.

⚠ Tip-over Hazards

Occupants, equipment and materials shall not exceed the maximum platform capacity or the maximum platform capacity of the platform extension. Weight in trays is part of the total platform load.

Maximum capacity - GR-12 and GR-15	
Standard platform	227 kg
Work tray station (option)	22 kg
Maximum occupants	1
AWP platform	
Maximum occupants	1
Maximum capacity - GR-20	
Standard platform	159 kg
Maximum occupants	1
AWP platform	
Maximum occupants	1

Work Area Safety



Do not raise the platform unless the machine is on a firm, level surface.

Do not depend on the tilt alarm as a level indicator. The tilt alarm sounds at the platform controls and the ground controls when the machine is on a severe slope.



If the tilt alarm sounds:
Lower the platform. Move the machine to a firm, level surface. If the tilt alarm sounds when the platform is raised, use extreme caution to lower the platform.

Do not drive over 0.8 km/h with the platform raised.

When raising the platform, follow ratings for allowable manual force and number of occupants on the next page.



Do not operate the machine in strong or gusty winds. Do not increase the surface area of the platform or the load. Increasing the area exposed to the wind will decrease machine stability.

The machine is rated for indoor use only. Do not raise the platform when wind speeds may exceed 0 m/s



Use extreme care and slow speeds while driving the machine in the stowed position across uneven terrain, debris, unstable or slippery surfaces and near holes and drop-offs.

Do not drive the machine on or near uneven terrain, unstable surfaces or other hazardous conditions with the platform raised.

Do not use the machine as a crane.

Do not push the machine or other objects with the platform.

Do not contact adjacent structures with the platform.

Do not tie the platform to adjacent structures.

Do not place loads outside the platform perimeter.

The work station tray is considered part of the platform.

Do not use the platform controls to free a platform that is caught, snagged or otherwise prevented from normal motion by an adjacent structure. All personnel must be removed from the platform before attempting to free the platform using the ground controls.



Work Area Safety



Do not push off or pull toward any object outside of the platform.



Do not place or attach fixed or overhanging loads to any part of this machine.

Do not place ladders or scaffolds in the platform or against any part of this machine.

Model	Maximum allowable manual force	Maximum number of occupants
CE	200 N	1

Do not alter or disable the limit switches.

Do not alter or disable machine components that in any way affect safety and stability.

Do not replace items critical to machine stability with items of different weight or specification.

Do not use batteries that weigh less than the original equipment. Batteries are used as counterweight and are critical to machine stability. Each battery must weigh 28 kg.

Do not modify or alter an aerial work platform without prior written permission from the manufacturer. Mounting attachments for holding tools or other materials onto the platform, toeboards or guard rail system can increase the weight in the platform and the surface area of the platform or the load.



Do not transport tools and materials unless they are evenly distributed and can be safely handled by person(s) in the platform.



Do not use the machine on a moving or mobile surface or vehicle.

Be sure all tires are in good condition, castle nuts are properly tightened and cotter pins are properly installed.

Work Area Safety

▲ Crushing Hazard

Keep hands and limbs out of mast.

Do not work under the platform or mast without the battery cover raised.

Use common sense and planning when operating the machine with the controller from the ground. Maintain safe distances between the operator, the machine and fixed objects.

▲ Operation on Slopes Hazards

Do not drive the machine on a slope that exceeds the slope and side slope rating of the machine. Slope rating applies to machines in the stowed position.

Maximum slope rating, stowed position	30% (17°)
Maximum side slope rating, stowed position	30% (17°)

Note: Slope rating is subject to ground conditions and adequate traction.

▲ Fall Hazards

The guard rail system provides fall protection. If occupant(s) of the platform are required to wear personal fall protection equipment (PFPE) due to job site or employer rules, PFPE and its use shall be in accordance with the PFPE manufacturer's instructions and applicable governmental requirements. Attach the lanyard to the anchor provided in the platform.

Keep the platform floor clear of debris.

Close the entry gate before operating.



Do not sit, stand or climb on the platform guard rails. Maintain a firm footing on the platform floor at all times.



Do not climb down from the platform when raised.

Do not enter or exit the platform unless the machine is in the stowed position.



Work Area Safety

⚠ Collision Hazards

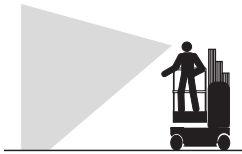

Be aware of limited sight distance and blind spots when driving or operating.

Be aware of extended platform position when moving the machine.

The machine must be on a level surface or secured before releasing the brakes.

Operators must comply with employer, job site and governmental rules regarding use of personal protective equipment.



Check the work area for overhead obstructions or other possible hazards.



Be aware of crushing hazards when grasping the platform guard rail.



Do not lower the platform unless the area below is clear of personnel and obstructions.



Limit travel speed according to the condition of the ground surface, congestion, slope, location of personnel, and any other factors which may cause collision.

Do not operate a machine in the path of any crane or moving overhead machinery unless the controls of the crane have been locked out and/or precautions have been taken to prevent any potential collision.

No stunt driving or horseplay while operating a machine.



Work Area Safety

▲ Bodily Injury Hazard

Do not operate the machine with a hydraulic oil or air leak. An air leak or hydraulic leak can penetrate and/or burn skin.

Improper contact with components under any cover will cause serious injury. Only trained maintenance personnel should access compartments. Access by the operator is only advised when performing a pre-operation inspection. All compartments must remain closed and secured during operation.

▲ Explosion and Fire Hazards

Do not operate the machine or charge the battery in hazardous locations or locations where potentially flammable or explosive gases or particles may be present.

▲ Damaged Machine Hazards

Do not use a damaged or malfunctioning machine.

Conduct a thorough pre-operation inspection of the machine and test all functions before each work shift. Immediately tag and remove from service a damaged or malfunctioning machine.

Be sure all maintenance has been performed as specified in this manual and the appropriate Genie service manual.

Be sure all decals are in place and legible.

Be sure the operator's, safety and responsibilities manuals are complete, legible and in the storage container located on the machine.

▲ Component Damage Hazards

Do not use any battery charger greater than 24V to charge the batteries.

Do not use the machine as a ground for welding.

Work Area Safety

⚠ Battery Safety

Burn Hazards



Batteries contain acid. Always wear protective clothing and eye wear when working with batteries.

Avoid spilling or contacting battery acid. Neutralize battery acid spills with baking soda and water.

Do not expose the batteries or the charger to water or rain during charging.

Explosion Hazards

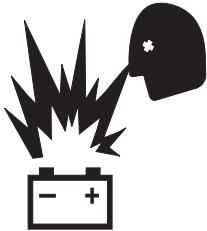

Keep sparks, flames and lighted tobacco away from batteries. Batteries emit explosive gas.

The battery tray should remain open during the entire charging cycle.



Do not contact the battery terminals or the cable clamps with tools that may cause sparks.



Component Damage Hazard

Do not use any battery charger greater than 24V to charge the batteries.

Do not use the machine as a ground for welding.

Electrocution/Burn Hazards



Connect the battery charger to a grounded, AC 3-wire electrical outlet only.

Inspect daily for damaged cords, cables and wires. Replace damaged items before operating.

Avoid electrical shock from contact with battery terminals. Remove all rings, watches and other jewelry.

Tip-over Hazard

Do not use batteries that weigh less than the original equipment. Batteries are used as counterweight and are critical to machine stability. Each battery must weigh 28 kg.

Lifting Hazard

Use the appropriate number of people and proper lifting techniques when lifting batteries.

Lockout After Each Use

- 1 Select a safe parking location—firm level surface, clear of obstruction and traffic.
- 2 Lower the platform.
- 3 Turn the key switch to the off position and remove the key to secure from unauthorized use.
- 4 Charge the batteries.



Legend

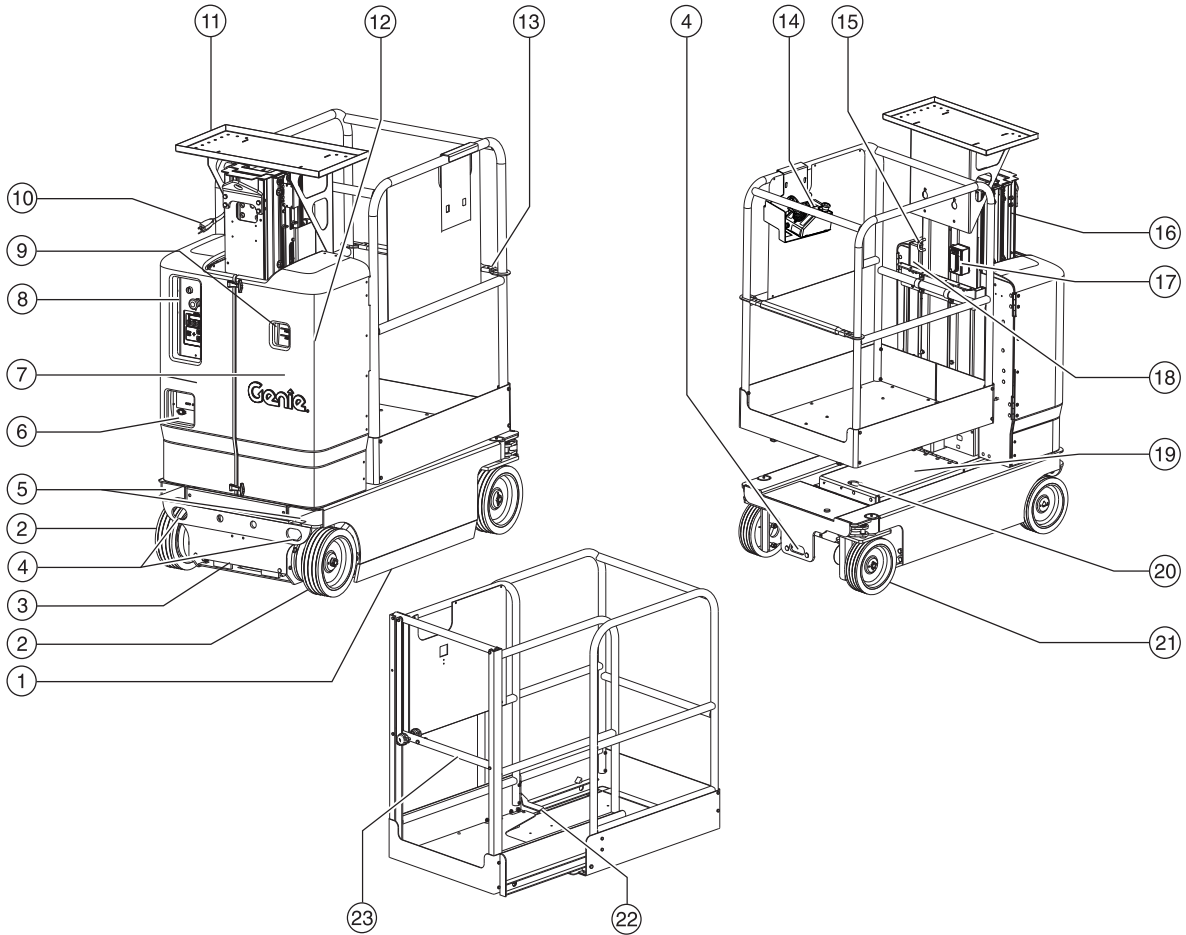

- 1 Pothole guard
- 2 Non-steer tire
- 3 Emergency lowering valve
- 4 Transport tie-down
- 5 Forklift pockets
- 6 Battery charger display
- 7 Covers
- 8 Ground controls
- 9 Hydraulic oil level indicator

- 10 Power to platform/battery charger connection for optional inverter
- 11 Work station tray (if equipped)
- 12 Brake release pump knob (under covers)
- 13 Sliding mid-rail
- 14 Platform controls
- 15 Lanyard anchorage points
- 16 Mast

- 17 GFCI outlet
- 18 Manual storage container
- 19 Battery compartment cover
- 20 Battery cover latch
- 21 Steer tire
- 22 Platform extension release pedal
- 23 Platform extension entry gate

Controls

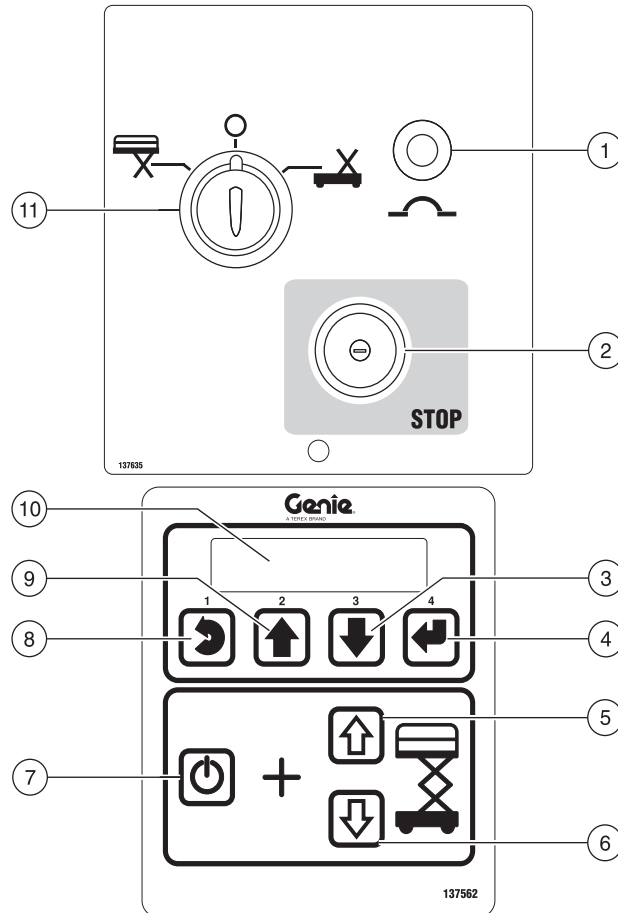

Ground Control Panel

- | | |
|--|---|
| <p>1 7A breaker for electrical circuits</p> <p>2 Red Emergency Stop button
Push in the red Emergency Stop button to the off position to stop all functions. Pull out the red Emergency Stop button to the on position to operate the machine.</p> <p>3 Menu down button</p> <p>4 Menu enter button</p> <p>5 Platform up button</p> <p>6 Platform down button</p> | <p>7 Lift function enable button
Press and hold this button to activate the lift function.</p> <p>8 Menu escape button</p> <p>9 Menu up button</p> <p>10 LCD diagnostic readout</p> <p>11 Key switch for platform/off/ground selection
Turn the key switch to the platform position and the platform controls will operate. Turn the key switch to the off position and the machine will be off. Turn the key switch to the ground position and the ground controls will operate.</p> |
|--|---|

Controls

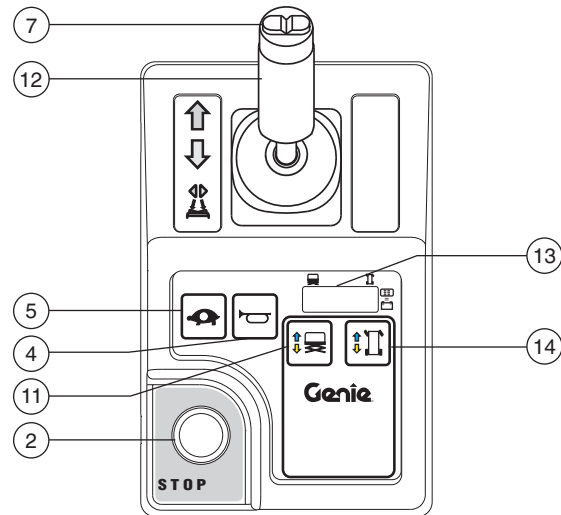
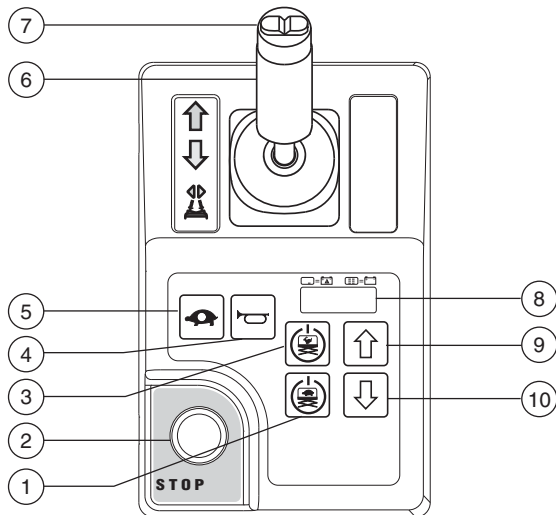

Platform Control Panel

1 Low speed lift enable button

Press and hold this button to activate the low speed platform function.



5 Drive speed select button

Press this button to activate the slow drive function. The indicator light will be on when slow drive is selected.



2 Red Emergency Stop button

Push in the red Emergency Stop button to the off position to stop all functions. Pull out the red Emergency Stop button to the on position to operate the machine.

6 Proportional control handle and function enable switch for drive function

Drive function: Press and hold the function enable switch to enable the drive function on the platform control handle. Move the control handle in the direction indicated by the blue arrow on the control panel and the machine will move in the direction that the blue arrow points. Move the control handle in the direction indicated by the yellow arrow on the control panel and the machine will move in the direction that the yellow arrow points.

3 High speed lift enable button

Press and hold this button to activate the high speed platform function.



4 Horn button

Press the horn button and the horn will sound. Release the horn button and the horn will not sound.





Controls

7 Thumb rocker switch for steer function

Press the left side of the thumb rocker and the machine will turn in the direction the blue triangle points on the platform control panel.



Press the right side of the thumb rocker and the machine will turn in the direction the yellow triangle points on the platform control panel.



8 LED diagnostic readout / battery charge indicator

9 Platform up button

Press and hold the platform up button and the platform will raise.



10 Platform down button

Press and hold the platform down button and the platform will lower.



11 Lift function button

Push this button to activate the lift function.

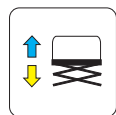

12 Proportional control handle and function enable switch for drive, steer, and lift functions

Lift function: Press and hold the function enable switch to enable the lift function on the platform control handle. Move the control handle in the direction indicated by the blue arrow and the platform will raise. Move the control handle in the direction indicated by the yellow arrow and the platform will lower. The descent alarm should sound while the platform is lowering.

Drive function: Press and hold the function enable switch to enable the drive function on the platform control handle. Move the control handle in the direction indicated by the blue arrow on the control panel and the machine will move in the direction that the blue arrow points. Move the control handle in the direction indicated by the yellow arrow on the control panel and the machine will move in the direction that the yellow arrow points.

13 LED diagnostic readout, battery charge indicator and lift/drive mode indicator

14 Drive function button

Push this button to activate the drive function.

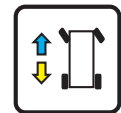

Inspections



Do Not Operate Unless:

- You learn and practice the principles of safe machine operation contained in this operator's manual.
 - 1 Avoid hazardous situations.
 - 2 Always perform a pre-operation inspection.**
- Know and understand the pre-operation inspection before going on to the next section.**
- 3 Always perform function tests prior to use.
 - 4 Inspect the workplace.
 - 5 Only use the machine as it was intended.

Pre-operation Inspection Fundamentals

It is the responsibility of the operator to perform a pre-operation inspection and routine maintenance.

The pre-operation inspection is a visual inspection performed by the operator prior to each work shift. The inspection is designed to discover if anything is apparently wrong with a machine before the operator performs the function tests.

The pre-operation inspection also serves to determine if routine maintenance procedures are required. Only routine maintenance items specified in this manual may be performed by the operator.

Refer to the list on the next page and check each of the items.

If damage or any unauthorized variation from factory delivered condition is discovered, the machine must be tagged and removed from service.

Repairs to the machine may only be made by a qualified service technician, according to the manufacturer's specifications. After repairs are completed, the operator must perform a pre-operation inspection again before going on to the function tests.

Scheduled maintenance inspections shall be performed by qualified service technicians, according to the manufacturer's specifications and the requirements listed in the responsibilities manual.



Inspections

Pre-operation Inspection

- Be sure that the operator's, safety and responsibilities manuals are complete, legible and in the storage container located in the platform.
- Be sure that all decals are legible and in place. See Inspections section.
- Check for hydraulic oil leaks and proper oil level. Add oil if needed. See Maintenance section.
- Check for battery fluid leaks and proper fluid level. Add distilled water if needed. See Maintenance section.

Check the following components or areas for damage, improperly installed or missing parts and unauthorized modifications:

- Electrical components, wiring and electrical cables
- Hydraulic power unit, reservoir, hoses, fittings, cylinders and manifolds
- Battery pack and connections
- Drive motors
- Tires and wheels
- Ground strap
- Limit switches, alarms and horn
- Alarms and beacons (if equipped)
- Nuts, bolts and other fasteners
- Platform entry mid-rail bar, chain or gate
- Sequencing cables and pulleys

- Pothole guards
- Lanyard anchorage points
- Platform extension (if equipped)
- Work trays (if equipped)
- Brake release components
- Battery cover
- Mast columns and counterweight
- Platform control joystick

Check entire machine for:

- Cracks in welds or structural components
- Dents or damage to machine
- Excessive rust, corrosion or oxidation
- Be sure that all structural and other critical components are present and all associated fasteners and pins are in place and properly tightened.

Note: If the platform must be raised to inspect the machine, make sure that the battery cover is in place. See Operating Instructions section.

Inspections



Do Not Operate Unless:

- You learn and practice the principles of safe machine operation contained in this operator's manual.
 - 1 Avoid hazardous situations.
 - 2 Always perform a pre-operation inspection.
 - 3 Always perform function tests prior to use.**

Know and understand the function tests before going on to the next section.

- 4 Inspect the workplace.
- 5 Only use the machine as it was intended.

Function Test Fundamentals

The function tests are designed to discover any malfunctions before the machine is put into service. The operator must follow the step-by-step instructions to test all machine functions.

A malfunctioning machine must never be used. If malfunctions are discovered, the machine must be tagged and removed from service. Repairs to the machine may only be made by a qualified service technician, according to the manufacturer's specifications.

After repairs are completed, the operator must perform a pre-operation inspection and function tests again before putting the machine into service.

Inspections

At the Ground Controls

- 1 Select a test area that is firm, level and free of obstruction.
 - 2 Be sure the batteries are connected.
 - 3 Pull out the platform and ground red Emergency Stop button to the on position.
 - 4 Turn the key switch to ground control.
 - 5 Observe the diagnostic LED readout on the platform controls.
- ⊙ Result: The LED should look like the picture below.



- 6 Observe the diagnostic LCD readout on the ground controls.
- ⊙ Result: The LCD should display the model and hour meter.

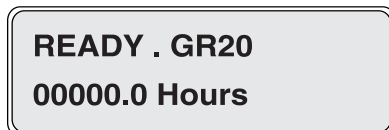

Test Emergency Stop

- 7 Push in the ground red Emergency Stop button to the off position.
- ⊙ Result: No functions should operate.
- 8 Pull out the red Emergency Stop button to the on position.

Test the Up/Down Functions

The audible warnings on this machine and the standard horn all come from the same central alarm. The horn is a constant tone. The descent alarm sounds at 60 beeps per minute. The alarm sounds at 180 beeps per minute when the pothole guards have not deployed and when the machine is not level. An optional automotive-style horn is also available.

- 9 Do not press the lift function enable button.
 - 10 Press the platform up or platform down button.
- ⊙ Result: The lift function should not operate.
- 11 Do not press the platform up or platform down buttons.
 - 12 Press the lift function enable button.
- ⊙ Result: The lift function should not operate.
- 13 Press and hold the lift function enable button, and press the platform up button.
- ⊙ Result: The platform should raise.
- 14 Press and hold the lift function enable button, and press the platform down button.
- ⊙ Result: The platform should lower. The descent alarm should sound while the platform is lowering.



Inspections

Test Emergency Lowering

- 15 Activate the up function by pressing the lift enable button and platform up button, and raise the platform approximately 60 cm.
- 16 Pull the emergency lowering knob located at the base of the machine below the mast.
- ⊙ Result: The platform should lower. The descent alarm will not sound.
- 17 Turn the key switch to platform control.

At the Platform Controls

Test Emergency Stop

- 18 Push in the platform red Emergency Stop button to the off position.
- ⊙ Result: No functions should operate.

Test the Horn

- 19 Pull out the red Emergency Stop button to the on position.
- 20 Press the horn button.
- ⊙ Result: The horn should sound.

Use the button pattern on the platform controls to determine which of these next two function tests to perform.

Use this function test procedure if the decal on your platform controls has these buttons.



Test the Function Enable Switch and the Up/Down Functions

- 21 Do not hold the function enable switch on the control handle.
- 22 Slowly move the control handle in the direction indicated by the blue arrow, then in the direction indicated by the yellow arrow.
- ⊙ Result: No functions should operate.
- 23 Do not press the high speed or low speed lift enable buttons.
- 24 Press the platform up or platform down button.
- ⊙ Result: The lift function should not operate.
- 25 Do not press the platform up or platform down buttons.



Inspections

- | | |
|--|---|
| <p>26 Press the high speed or low speed lift enable button.</p> <p>⊙ Result: The lift function should not operate.</p> <p>27 Press and hold the high speed lift enable button.</p> <p>28 Press the platform up button.</p> <p>⊙ Result: The platform should raise. The pothole guards should deploy.</p> <p>29 Release the high speed lift enable button or the platform up button.</p> <p>⊙ Result: The platform should stop raising.</p> <p>30 Press and hold the high speed lift enable button.</p> <p>31 Press the platform down button.</p> <p>⊙ Result: The platform should lower. The descent alarm should sound while the platform is lowering.</p> <p>32 Release the high speed lift enable button or the platform down button.</p> <p>⊙ Result: The platform should stop lowering.</p> | <p>33 Press and hold the low speed lift enable button.</p> <p>34 Press the platform up button.</p> <p>⊙ Result: The platform should raise. The pothole guards should deploy.</p> <p>35 Release the low speed lift enable button or the platform up button.</p> <p>⊙ Result: The platform should stop raising.</p> <p>36 Press and hold the low speed lift enable button.</p> <p>37 Press the platform down button.</p> <p>⊙ Result: The platform should lower at the same descent speed as high speed. The descent alarm should sound while the platform is lowering.</p> <p>38 Release the low speed lift enable button or the platform down button.</p> <p>⊙ Result: The platform should stop lowering.</p> |
|--|---|



Inspections

Use this function test procedure if the decal on your platform controls has these buttons.



Test the Function Enable Switch and the Up/Down Functions

- 39 Do not hold the function enable switch on the control handle.
- 40 Slowly move the control handle in the direction indicated by the blue arrow, then in the direction indicated by the yellow arrow.
 - ⦿ Result: No functions should operate.
- 41 Press the lift function button.
- 42 Wait seven seconds for the lift function to time out.
- 43 Slowly move the control handle in the direction indicated by the blue arrow, then in the direction indicated by the yellow arrow.
 - ⦿ Result: The lift function should not operate.
- 44 Press the lift function button.
- 45 Press and hold the function enable switch on the control handle. Slowly move the control handle in the direction indicated by the blue arrow.
 - ⦿ Result: The platform should raise.

- 46 Release the control handle.
 - ⦿ Result: The platform should stop raising.
- 47 Press and hold the function enable switch on the control handle. Slowly move the control handle in the direction indicated by the yellow arrow.
 - ⦿ Result: The platform should lower. The descent alarm should sound while the platform is lowering.

Test the Drive Function Button

Use this function test procedure if the decal on your platform controls has these buttons.



- 48 Press the drive function button (if equipped).
 
- 49 Wait seven seconds for the drive function to time out.
- 50 Slowly move the control handle in the direction indicated by the blue arrow, then in the direction indicated by the yellow arrow.
 - ⦿ Result: No functions should operate.



Inspections

Test the Steering

Note: When performing the steer and drive function tests, stand in the platform facing the steer end of the machine.

- 51 Press the drive function button (if equipped).



- 52 Press and hold the function enable switch on the control handle.
- 53 Press the thumb rocker switch on top of the control handle in the direction indicated by the blue triangle on the control panel.
- ⦿ Result: The steer wheels should turn in the direction indicated by the blue triangle.
- 54 Press the thumb rocker switch on top of the control handle in the direction indicated by the yellow triangle, on the control panel.
- ⦿ Result: The steer wheels should turn in the direction indicated by the yellow triangle.

Test Drive and Braking

- 55 Press the drive function button (if equipped).



- 56 Press and hold the function enable switch on the control handle.
- 57 Slowly move the control handle in the direction indicated by the blue arrow on the control panel until the machine begins to move, then return the control handle to the center position.
- ⦿ Result: The machine should move in the direction that the blue arrow points on the control panel, then come to an abrupt stop when the control handle is returned to the center position.
- 58 Slowly move the control handle in the direction indicated by the yellow arrow on the control panel until the machine begins to move, then return the control handle to the center position.
- ⦿ Result: The machine should move in the direction that the yellow arrow points on the control panel, then come to an abrupt stop when the control handle is returned to the center position.

Note: The brakes must be able to hold the machine on any slope it is able to climb.



Inspections

Test the Tilt Sensor Operation

Note: Perform this test from the ground with the platform controller. Do not stand in the platform.

- 59 Fully lower the platform.
- 60 Place a 2x4 or similar piece of wood under both wheels on one side and drive the machine up onto them.
- 61 Raise the platform approximately 2.1 m from the ground.
 - ⊙ Result: The platform should stop and the tilt alarm will sound at 180 beeps per minute. The platform controls LED readout should display LL and the ground controls LCD should display LL: Machine Tilted.
- 62 Press the drive function button (if equipped). 
- 63 Press and hold the function enable switch on the control handle.
- 64 Move the control handle in the direction indicated by the blue arrow, then move the control handle in the direction indicated by the yellow arrow.
 - ⊙ Result: The drive function should not work in either direction.
- 65 Lower the platform and remove both pieces of wood.

Test Elevated Drive Speed

- 66 Raise the platform approximately 1.2 m from the ground.
 - 67 Press the drive function button (if equipped). 
 - 68 Press and hold the function enable switch on the control handle. Slowly move the control handle to full drive position.
 - ⊙ Result: The maximum achievable drive speed with the platform raised should not exceed 22 cm/s.
- If the drive speed with the platform raised exceeds 22 cm/s, immediately tag and remove the machine from service.

Inspections

Test the Pothole Guards

Note: The pothole guards should automatically deploy when the platform is raised. The pothole guards activate limit switches that allow the machine to continue to function. If the pothole guards do not deploy, an alarm sounds and the machine will not drive or steer.

69 Raise the platform.

⊙ Result: When the platform is raised 1.2 m from the ground, the pothole guards should deploy.

70 Press on the pothole guards on one side, and then the other.

⊙ Result: The pothole guards should not move.

71 Lower the platform

⊙ Result: The pothole guards should return to the stowed position.

72 Place a 2x4 or similar piece of wood under a pothole guard.

73 Raise the platform.

⊙ Result: Before the platform is raised 2.1 m from the ground, an alarm should sound. The platform controls LED readout should display PHS and the ground controls LCD should display PHS: Pothole Guard Stuck.

74 Press the drive function button (if equipped).



75 Press and hold the function enable switch on the control handle.

76 Slowly move the control handle in the direction indicated by the blue arrow, then in the direction indicated by the yellow arrow.

⊙ Result: The machine should not move forward or backward.

77 Press the drive function button (if equipped).



78 Press and hold the function enable switch on the control handle.

79 Press the thumb rocker switch on top of the control handle in the direction indicated by the blue and yellow triangles on the control panel.

⊙ Result: The steer wheels should not turn left or right.

80 Lower the platform.

81 Remove the 2x4 or similar piece of wood.

Inspections



Do Not Operate Unless:

- You learn and practice the principles of safe machine operation contained in this operator's manual.
 - 1 Avoid hazardous situations.
 - 2 Always perform a pre-operation inspection.
 - 3 Always perform function tests prior to use.
 - 4 **Inspect the workplace.**

Know and understand the workplace inspection before going on to the next section.

- 5 Only use the machine as it was intended.

Workplace Inspection Checklist

Be aware of and avoid the following hazardous situations:

- drop-offs or holes
- bumps, floor obstructions or debris
- sloped surfaces
- unstable or slippery surfaces
- overhead obstructions and high voltage conductors
- hazardous locations
- inadequate surface support to withstand all load forces imposed by the machine
- wind and weather conditions
- the presence of unauthorized personnel
- other possible unsafe conditions

Workplace Inspection Fundamentals

The workplace inspection helps the operator determine if the workplace is suitable for safe machine operation. It should be performed by the operator prior to moving the machine to the workplace.

It is the operator's responsibility to read and remember the workplace hazards, then watch for and avoid them while moving, setting up and operating the machine.



Inspections

Inspection for Decals with Symbols

Determine whether the decals on your machine have words or symbols. Use the appropriate inspection to verify that all decals are legible and in place.

Part No.	Decal Description	Qty
28174	Label – Power to Platform, 230V	2
28235	Label – Power to Platform, 115V	2
40434	Label – Lanyard Anchorage Point	1
43658	Label – Power to Charger, 230V	1
44980	Label – Power to Charger, 115V	1
52475	Label – Transport Tie-down	3
72086	Label – Lifting Point	1
72184	Cosmetic – Genie Runabout	2
72188	Label – Directional Arrows	2
82473	Label – Compartment Access	1
82481	Label – Battery/Charger Safety	1
82487	Label – Read the Manual	2
82495	Label – Brake Release Safety and Operating Instructions	1
82614	Warning – Collision Hazard	1
82666	Label – Forklift Pocket	2
82830	Label – Max Manual Force, 200 N, CE	1
82836	Label – Emergency Lowering	1
97810	Cosmetic – GR-12	2
97811	Cosmetic – GR-15	2
97812	Cosmetic – GR-20	2
97815	Label – Lower Mid-rail	6
97873	Label – Max Capacity, Work Station Tray, 22 kg, GR-12, GR-15	1
97899	Label – Use Safety Chock	1
114334	Label – Electrocutation Hazard, Plug	1
114338	Label – Tip-over Hazard, Tilt Alarm	1
133015	Danger – Electrocutation hazard	1
133144	Label – Transport Diagram	2
133146	Danger – Tip-over Hazard, Batteries	1
133147	Label – Tip-over Hazard, Limit Switch	1
137605	Label – Emergency Stop, Platform Control	1
137635	Label – Ground Control Panel	1
137636	Overlay – Platform Control Panel	1

Part No.	Decal Description	Qty
137656	Label – Drive/Steer Direction, Platform Control	1
1256702	Overlay – Platform Control Panel	1
1257923	Label – Smartlink	2
T106667	Label – Wheel Load, GR-12	4
T106668	Label – Wheel Load, GR-15	4
T106669	Label – Wheel Load, GR-20	4
T108737	Label – Maximum Capacity, 227 kg, GR-12, GR-15 (models with standard platform)	1
T108738	Label – Maximum Capacity, 159 kg, GR-12, GR-15 (models with standard platform or with AWP platform)	1

Inspections

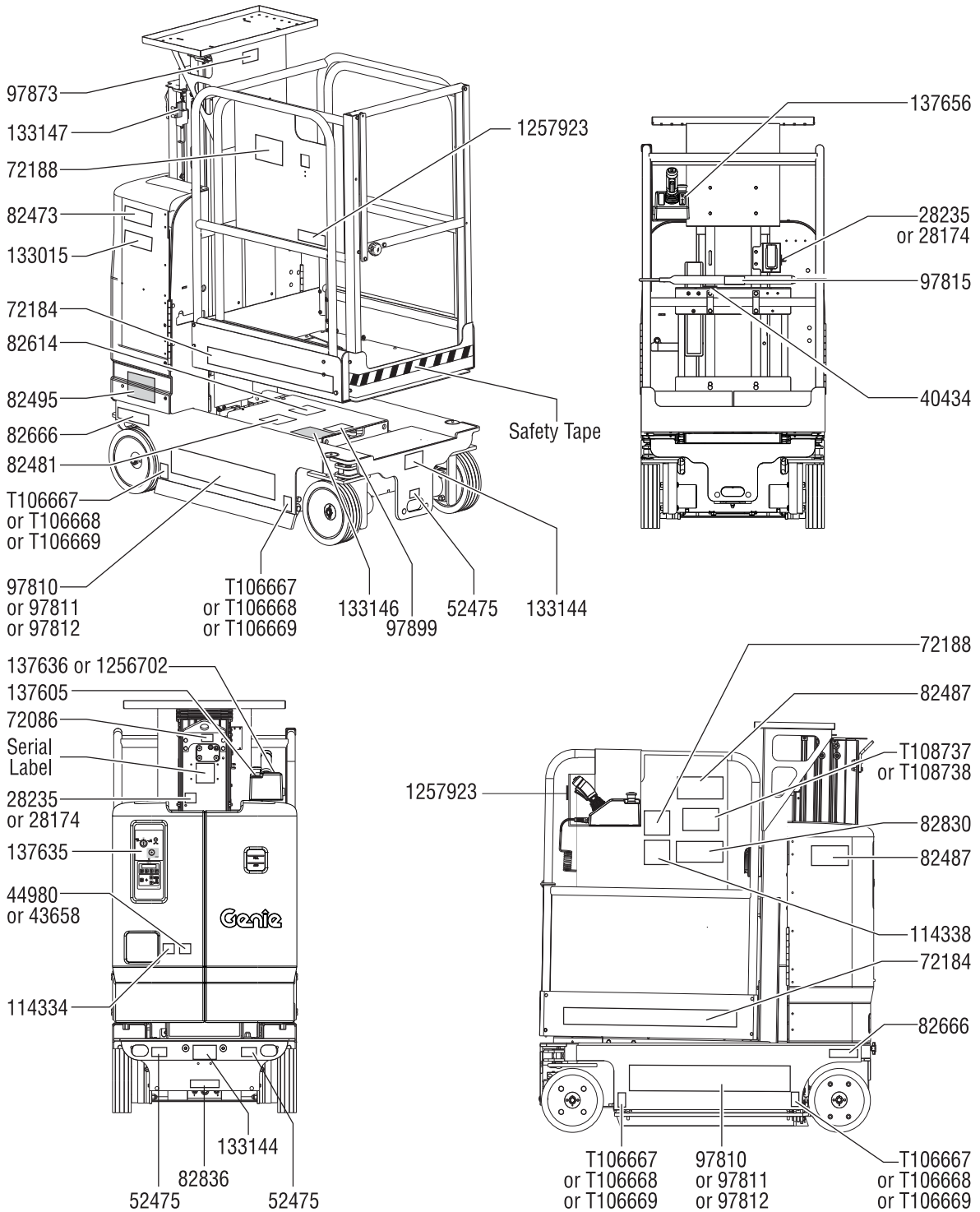

Operating Instructions



Do Not Operate Unless:

- You learn and practice the principles of safe machine operation contained in this operator's manual.
 - 1 Avoid hazardous situations.
 - 2 Always perform a pre-operation inspection.
 - 3 Always perform function tests prior to use.
 - 4 Inspect the workplace.
 - 5 **Only use the machine as it was intended.**

Fundamentals

The Operating Instructions section provides instructions for each aspect of machine operation. It is the operator's responsibility to follow all the safety rules and instructions in the operator's, safety and responsibilities manuals.

Using the machine for anything other than lifting personnel, along with their tools and materials, to an aerial work site is unsafe and dangerous.

Only trained and authorized personnel should be permitted to operate a machine. If more than one operator is expected to use a machine at different times in the same work shift, they must all be qualified operators and are all expected to follow all safety rules and instructions in the operator's, safety and responsibilities manuals. That means every new operator should perform a pre-operation inspection, function tests, and a workplace inspection before using the machine.

Operating Instructions

Emergency Stop

Push in the red Emergency Stop button to the off position at the ground controls or the platform controls to stop all functions.

Repair any function that operates when either red Emergency Stop button is pushed in.

Emergency Lowering

Pull the emergency lowering knob to lower the platform.

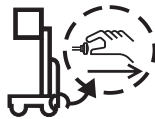

Operation from Ground

- 1 Be sure the battery pack is connected before operating the machine.
- 2 Turn the key switch to ground control.
- 3 Pull out both ground and platform red Emergency Stop buttons to the on position.

To Position Platform

- 1 At the control panel, press and hold the lift function enable button.
 - 2 Press the platform up or down button.
- Drive and steer functions are not available from the ground controls.

Operation from Platform

- 1 Be sure the battery pack is connected before operating the machine.
- 2 Turn the key switch to platform control.
- 3 Pull out both ground and platform red Emergency Stop buttons to the on position.

Controller Identification

These machines were produced with two different styles of platform controls. Use the button pattern on the platform controls to determine which instructions apply to your machine.

Use these instructions if the decal on your platform controls has these buttons.

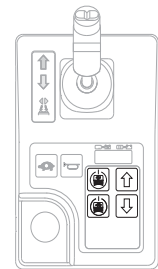

To Position Platform

- 1 Press and hold the high or low speed lift enable button.
- 2 Press the platform up or platform down button.



Operating Instructions

To Steer

- 1 Press and hold the drive/steer function enable switch on the control handle.
- 2 Turn the steer wheels with the thumb rocker switch located on the top of the control handle.



To Drive

- 1 Press and hold the drive/steer function enable switch on the control handle.
- 2 Increase speed: Slowly move the control handle off center.
Decrease speed: Slowly move the control handle toward center.
Stop: Return the control handle to center or release the function enable switch.

Use the color-coded direction arrows on the platform controls and on the platform to identify the direction the machine will travel.

Machine travel speed is restricted when the platform is raised.

Battery condition will affect machine performance. Machine drive speed and function speed will drop when the battery level indicator is flashing.

To select drive speed

The drive controls can operate in two different drive speed modes while in the stowed position. When the drive speed button light is on, slow drive speed mode is active. When the drive speed button light is off, fast drive speed mode is active.

Press the drive speed button to select the desired drive speed.



Note: When the platform is elevated, the drive speed button light is always on, indicating elevated drive speed.



Operating Instructions

Controller Identification

Use these instructions if the decal on your platform controls has these buttons.



To Position Platform

- 1 Press the lift function button. On the LCD screen, a circle below the lift function symbol will turn on.



If the control handle is not moved within seven seconds of pushing the lift function button, the circle below the lift function symbol will turn off and lift function will not operate. Press the lift function button again.

- 2 Press and hold the function enable switch on the control handle.
- 3 Move the control handle according to the markings on the control panel.

To Steer

- 1 Press the drive function button. On the LCD screen, a circle below the drive function symbol will turn on.

If the control handle is not moved within seven seconds of pushing the drive function button, the circle below the drive function symbol will turn off and drive function will not operate. Press the drive function button again.

- 2 Turn the steer wheels with the thumb rocker switch located on the top of the control handle.



To Drive

- 1 Press the drive function button. On the LCD screen, a circle below the drive function symbol will turn on.

If the control handle is not moved within seven seconds of pushing the drive function button, the circle below the drive function symbol will turn off and drive function will not operate. Press the drive function button again.

- 2 Press and hold the function enable switch on the control handle.

- 3 Increase speed: Slowly move the control handle off center.

Decrease speed: Slowly move the control handle toward center.

Stop: Return the control handle to center or release the function enable switch.

Use the color-coded direction arrows on the platform controls and on the platform to identify the direction the machine will travel.

Machine travel speed is restricted when the platform is raised.

Battery condition will affect machine performance. Machine drive speed and function speed will drop when the battery level indicator is flashing.

Operating Instructions

To select drive speed

The drive controls can operate in two different drive speed modes while in the stowed position. When the drive speed button light is on, slow drive speed mode is active. When the drive speed button light is off, fast drive speed mode is active.

Press the drive speed button to select the desired drive speed.



Note: When the platform is elevated, the drive speed button light is always on, indicating elevated drive speed.

▲ Driving on a slope

Determine the slope and side slope ratings for the machine and determine the slope grade.



Maximum slope rating, stowed position: 30% (17°)



Maximum side slope rating, stowed position: 30% (17°)

Note: Slope rating is subject to ground conditions and adequate traction.

Press the drive speed button to the fast drive speed mode.

To determine the slope grade:

Measure the slope with a digital inclinometer OR use the following procedure.

You will need:

- carpenter's level
- straight piece of wood, at least 1 m long
- tape measure

Lay the piece of wood on the slope.

At the downhill end, lay the level on the top edge of the piece of wood and lift the end until the piece of wood is level.

While holding the piece of wood level, measure the vertical distance from the bottom of the piece of wood to the ground.

Divide the tape measure distance (rise) by the length of the piece of wood (run) and multiply by 100.

Example:

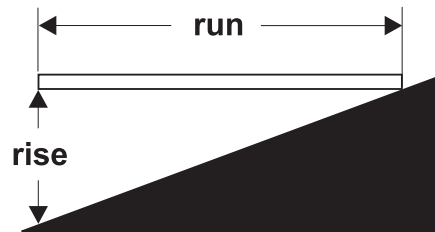

Piece of wood = 3.6 m

Run = 3.6 m

Rise = 0.3 m

$0.3 \text{ m} \div 3.6 \text{ m} = 0.083 \times 100 = 8.3\% \text{ grade}$

If the slope exceeds the maximum uphill, downhill or side slope rating, then the machine must be winched or transported up or down the slope. See Transport and Lifting section.

Operating Instructions

Operational indicator codes

If the platform controls LED or ground controls LCD diagnostic readout displays an operational indicator code such as LL, the fault condition must be repaired or removed before resuming machine operation. Push in and pull out the red Emergency Stop button to reset the system.



LED Readout

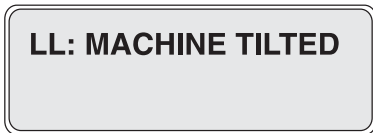

LCD Readout

Operational Indicator Codes

Code	Condition
LL	Off-Level
OL	Platform Overloaded
CH	Chassis Mode Operation
PHS	Pothole Guard Stuck
nd	No Drive (option)

For further information, please consult the appropriate Genie Service Manual. A code and a description of a code can also be viewed at the ground controls LCD display.

Platform Overload

If the platform controls LED diagnostic readout displays a flashing OL and the ground controls LCD diagnostic readout displays OL: Platform Overloaded, the platform is overloaded and no functions will operate. An alarm will sound.

- 1 Push in the Red Emergency stop button to the off position.
- 2 Remove weight from the platform.
- 3 Pull out the Red Emergency Stop button to the on position.

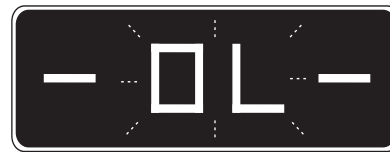

LED Readout



LCD Readout

Overload Recovery

If the ground controls LCD diagnostic readout displays Overload Recovery, the emergency lowering system has been used while the platform was overloaded. For information on how to reset this message, please consult the appropriate Genie Service Manual.

Operating Instructions

To Extend and Retract Platform (if equipped)

- 1 Step on the platform extension release pedal.
- 2 Grasp the platform guard rails carefully and push to extend the platform.
- 3 Step on the platform extension release pedal and pull the guard rails to retract the platform.

Operation From Ground with the Platform Controls

Maintain safe distances between the operator, machine and fixed objects.

Be aware of the direction the machine will travel when using the platform controls.

After Each Use

- 1 Select a safe parking location—firm level surface, clear of obstruction and traffic.
- 2 Lower the platform.
- 3 Turn the key switch to the off position and remove the key to secure from unauthorized use.
- 4 Charge the batteries.

Battery Level Indicator

Use the LED diagnostic readout to determine the battery level.

Note: When a blinking LO code appears on the platform controls LED display, the machine must be taken out of service and charged, otherwise all machine functions will be disabled.



Full Charge



Half Charge



Low Charge



LO Flashing



Operating Instructions



Battery and Charger Instructions

Observe and Obey:

- Do not use an external charger or booster battery.
- Charge the battery in a well-ventilated area.
- Use proper AC input voltage for charging as indicated on the charger.
- Use only a Genie authorized battery and charger.

To Charge Battery

- 1 Be sure the batteries are connected before charging the batteries.
- 2 Open the battery compartment. The compartment should remain open for the entire charging cycle.
- 3 Rest the cover against the chassis.
- 4 Lower the platform until the mast just contacts the battery cover.
- ▲ **Crushing hazard.** Keep hands clear of the battery cover when lowering the platform.
- 5 Turn the key switch to the off position.
- 6 Be sure that the battery cable connections are tight and free of corrosion.

Maintenance-free batteries

- 1 Connect the battery charger to a grounded AC circuit.
- 2 The charger will indicate when the battery is fully charged.

Standard Batteries

- 1 Remove the battery vent caps and check the battery acid level. If necessary, add only enough distilled water to cover the plates. Do not overfill prior to the charge cycle.
- 2 Replace the battery vent caps.
- 3 Connect the battery charger to a grounded AC circuit.
- 4 The charger will indicate when the battery is fully charged.
- 5 Check the battery acid level when the charging cycle is complete. Replenish with distilled water to the bottom of the fill tube. Do not overfill.



Operating Instructions

Dry Battery Filling and Charging Instructions

- 1 Remove the battery vent caps and permanently remove the plastic seal from the battery vent openings.
- 2 Fill each cell with battery acid (electrolyte) until the level is sufficient to cover the plates.

Do not fill to maximum level until the battery charge cycle is complete. Overfilling can cause the battery acid to overflow during charging. Neutralize battery acid spills with baking soda and water.

- 3 Install the battery vent caps.
- 4 Charge the battery.
- 5 Check the battery acid level when the charging cycle is complete. Replenish with distilled water to the bottom of the fill tube. Do not overfill.

Transport and Lifting Instructions





Observe and Obey:

- Genie provides this securement information as a recommendation. Drivers are solely responsible for making sure machines are properly secured and the correct trailer is selected pursuant to US Department of Transportation regulations, other localized regulations, and their company policy.
- Genie customers needing to containerize any lift or Genie product should source a qualified freight forwarder with expertise in preparing, loading and securing construction and lifting equipment for international shipment.
- Only qualified aerial lift operators should move the machine on or off the truck.
- The transport vehicle must be parked on a level surface.
- The transport vehicle must be secured to prevent rolling while the machine is being loaded.
- Be sure the vehicle capacity, loading surfaces and chains or straps are sufficient to withstand the machine weight. Genie lifts are very heavy relative to their size. See the serial label for the machine weight. See the inspections section for the serial label location.
- The machine must be on a level surface or secured before releasing the brakes.
- Do not drive the machine on a slope that exceeds the uphill, downhill or side slope rating. See Driving on a Slope in the Operating Instructions section.
- If the slope of the transport vehicle bed exceeds the uphill or downhill maximum slope rating, the machine must be loaded and unloaded using a winch as described in the brake release operation. See the Specifications section for the slope ratings.

Transport and Lifting Instructions

Brake Release Operation

- 1 Chock the wheels to prevent the machine from rolling. 
- 2 Be sure the winch line is properly secured to the drive chassis tie points and the path is clear of all obstructions.
- 3 Push in the black brake release knob to open the brake valve. 
- 4 Pump the red brake release pump knob.

After the machine is loaded:

- 1 Pull out the red Emergency Stop button at both the ground and platform controls to the on position, and turn the key switch to the platform position.
- 2 Press the drive function button (if equipped). 
- 3 Press and hold the function enable switch on the control handle. Move the control handle off center and immediately release it to reset the brakes.
- 4 Push the red Emergency stop button at both the ground and platform controls to the off position.

Towing the GR-12, the GR-15, and the GR-20 is not recommended. If the machine must be towed, do not exceed 3.2 km/h.

Transport and Lifting Instructions

Securing to Truck or Trailer for Transit

Always use the extension deck lock when the machine is transported.

Turn the key switch to the off position and remove the key before transporting.

Inspect the entire machine for loose or unsecured items.

Use the tie-down points on the chassis for anchoring down to the transport surface.

Use chains or straps of ample load capacity.

Use a minimum of 4 chains or straps.

Adjust the rigging to prevent damage to the chains.

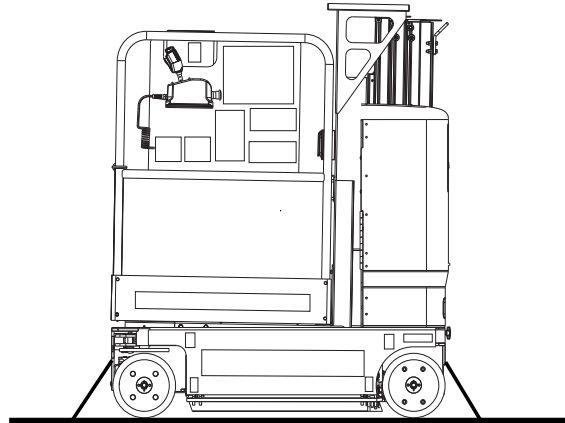
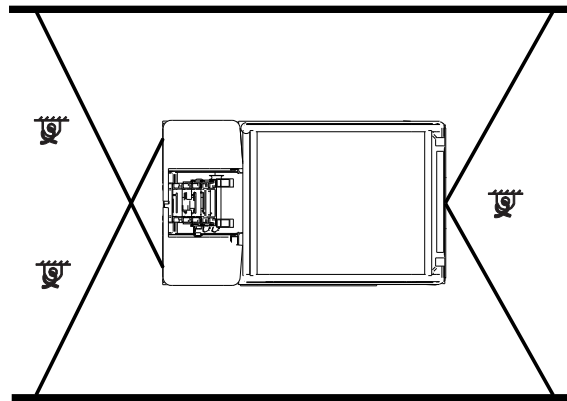

Transport and Lifting Instructions



Observe and Obey:

- ☑ Only qualified riggers should rig and lift the machine.
- ☑ Only qualified forklift operators should lift the machine with a forklift.
- ☑ Be sure the crane capacity, loading surfaces and straps or lines are sufficient to withstand the machine weight. See the serial label for the machine weight.

Loading the Machine With a Crane

Use the lifting eye mounted on the rear mast column.

Make sure the mast is fully lowered.

Inspect the entire machine and remove any loose or unsecured items.

Always place the lifting hook through the lifting eye so that it points away from the machine.

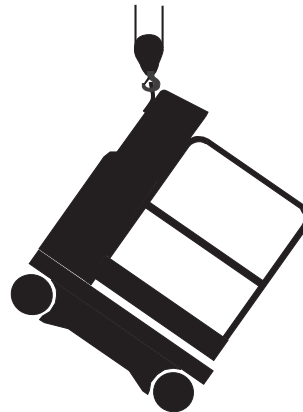

Maintenance



Observe and Obey:

- ☑ Only routine maintenance items specified in this manual shall be performed by the operator.
- ☑ Scheduled maintenance inspections shall be completed by qualified service technicians, according to the manufacturer's specifications and the requirements specified in the responsibilities manual.
- ☑ Dispose of material in accordance with governmental regulations.
- ☑ Use only Genie approved replacement parts.

Maintenance Symbols Legend

The following symbols have been used in this manual to help communicate the intent of the instructions. When one or more of the symbols appear at the beginning of a maintenance procedure, it conveys the meaning below.



Indicates that tools will be required to perform this procedure.



Indicates that new parts will be required to perform this procedure.

Check the Hydraulic Oil Level



Maintaining the hydraulic oil at the proper level is essential to machine operation. Improper hydraulic oil levels can damage hydraulic components. Daily checks allow the inspector to identify changes in oil level that might indicate the presence of hydraulic system problems.

Note: Perform this procedure with the platform in the stowed position.

- 1 Visually inspect the oil level in the hydraulic oil tank.
- ⊙ Result: The fluid level should be as marked on the tank.
- 2 Add oil as needed. Do not overfill.

Hydraulic oil specifications

Hydraulic oil type	Chevron Rando HD equivalent
--------------------	-----------------------------

Maintenance

Check the Batteries



Proper battery condition is essential to good machine performance and operational safety. Improper fluid levels or damaged cables and connections can result in component damage and hazardous conditions.

Note: This procedure does not need to be performed on machines with sealed or maintenance-free batteries.

- ▲ **Electrocution hazard.** Contact with hot or live circuits may result in death or serious injury. Remove all rings, watches and other jewelry.
- ▲ **Bodily injury hazard.** Batteries contain acid. Avoid spilling or contacting battery acid. Neutralize battery acid spills with baking soda and water.

Note: Perform this test after fully charging the batteries.

- 1 Put on protective clothing and eye wear.
- 2 Be sure that the battery cable connections are tight and free of corrosion.
- 3 Be sure that the battery hold-down brackets are in place and secure.

Note: Adding terminal protectors and a corrosion preventative sealant will help eliminate the corrosion on the battery terminals and cables.

Scheduled Maintenance

Maintenance performed quarterly, annually and every two years must be completed by a person trained and qualified to perform maintenance on this machine according to the procedures found in the service manual for this machine.

Machines that have been out of service for more than three months must receive the quarterly inspection before they are put back into service.



Specifications

Model	GR-12
Height, working maximum	5.3 m
Height, platform maximum	3.5 m
Height, stowed maximum	1.57 cm
Height, stowed maximum, standard platform with work station tray	1.62 m
Width	74.9 cm
Length, stowed	1.35 cm
Length, platform extended (option)	1.85 m
Platform dimensions, all models (length x width)	
Standard platform	88.9 x 74.9 cm
Standard platform with extension extended	139.7 x 74.9 cm
Standard AWP platform	69 x 51 cm
Narrow AWP platform	66 x 51 cm
Maximum capacity, standard platform	227 kg
Maximum capacity, AWP platform	159 kg
Turning radius (inside)	0 cm
Turning radius (outside)	132.1 cm
Ground clearance	6.5 cm
Weight	717 kg
(Machine weights vary with option configurations. See serial label for specific machine weight.)	
Power source	4 Batteries, 6V 225AH
AC outlet in platform	Standard
Maximum hydraulic pressure (functions)	207 bar
Tire size	25.4 x 7.6 x 2.5 cm

Airborne noise emissions

Sound pressure level at ground workstation <70 dBA

Sound pressure level at platform workstation <70 dBA

Total vibration value to which the hand/arm system is subjected does not exceed 2.5 m/s².

Highest root mean square value of weighted acceleration to which the whole body is subjected does not exceed 0.5 m/s².

Maximum slope rating, stowed position 30% (17°)

Maximum side slope rating, stowed position 30% (17°)

Note: Slope rating is subject to ground conditions and adequate traction.

Drive speeds

Stowed, maximum 4.0 km/h
12.2 m/10.9 sec

Platform raised, maximum 0.8 km/h
12.2 m/55 sec

Floor loading information

Tire load maximum 308 kg

Tire contact pressure 7.36 kg / cm²
721.3 kPa

Occupied floor pressure 936 kg / m²
9.18 kPa

Note: Floor loading information is approximate and does not incorporate different option configurations. It should be used only with adequate safety factors.

Continuous improvement of our products is a Genie policy. Product specifications are subject to change without notice or obligation.



Specifications

Model	GR-15
Height, working maximum	6.3 m
Height, platform maximum	4.5 m
Height, stowed maximum	1.57 cm
Height, stowed maximum, standard platform with work station tray	1.62 m
Width	74.9 cm
Length, stowed	1.35 m
Length, platform extended (option)	1.85 m
Platform dimensions, all models (length x width)	
Standard platform	88.9 x 74.9 cm
Standard platform with extension	139.7 x 74.9 cm extended
Standard AWP platform	69 x 51 cm
Narrow AWP platform	66 x 51 cm
Maximum capacity, standard platform	227 kg
Maximum capacity, AWP platform	159 kg
Turning radius (inside)	0 cm
Turning radius (outside)	132.1 cm
Ground clearance	6.5 cm
Weight	994 kg
(Machine weights vary with option configurations. See serial label for specific machine weight.)	
Power source	4 Batteries, 6V 225AH
AC outlet in platform	Standard
Maximum hydraulic pressure (functions)	207 bar
Tire size	25.4 x 7.6 x 2.5 cm

Airborne noise emissions	
Sound pressure level at ground workstation	<70 dBA
Sound pressure level at platform workstation	<70 dBA
Total vibration value to which the hand/arm system is subjected does not exceed 2.5 m/s ² .	
Highest root mean square value of weighted acceleration to which the whole body is subjected does not exceed 0.5 m/s ² .	
Maximum slope rating, stowed position	30% (17°)
Maximum side slope rating, stowed position	30% (17°)
Note: Slope rating is subject to ground conditions and adequate traction.	
Drive speeds	
Stowed, maximum	4.0 km/h 12.2 m/10.9 sec
Platform raised, maximum	0.8 km/h 12.2 m/55 sec
Floor loading information	
Tire load maximum	327 kg
Tire contact pressure	7.79 kg / cm ² 763.7 kPa
Occupied floor pressure	1210 kg / m ² 11.87 kPa
Note: Floor loading information is approximate and does not incorporate different option configurations. It should be used only with adequate safety factors.	
Continuous improvement of our products is a Genie policy. Product specifications are subject to change without notice or obligation.	



Specifications

Model	GR-20
Height, working maximum	7.9 m
Height, platform maximum	6.1 m
Height, stowed maximum	1.98 cm
Width	80 cm
Length, stowed	1.35 m
Length, platform extended (option)	1.86 m
Platform dimensions, all models (length x width)	
Standard platform	89.9 x 74.9 cm
Standard platform with extension extended	139.7 x 74.9 cm
Standard AWP platform	69 x 51 cm
Narrow AWP platform	66 x 51 cm
Maximum capacity, standard platform	159 kg
Maximum capacity, AWP platform	159 kg
Maximum capacity (stock picker platform)	159 kg
Turning radius (inside)	0 cm
Turning radius (outside)	134.6 cm
Ground clearance	6.5 cm
Weight	1112 kg
(Machine weights vary with option configurations. See serial label for specific machine weight.)	
Power source	4 Batteries, 6V 225AH
AC outlet in platform	Standard
Maximum hydraulic pressure (functions)	207 bar
Tire size	25.4 x 7.6 x 2.5 cm

Airborne noise emissions

Sound pressure level at ground workstation <70 dBA

Sound pressure level at platform workstation <70 dBA

Total vibration value to which the hand/arm system is subjected does not exceed 2.5 m/s².

Highest root mean square value of weighted acceleration to which the whole body is subjected does not exceed 0.5 m/s².

Maximum slope rating, stowed position 30% (17°)

Maximum side slope rating, stowed position 30% (17°)

Note: Slope rating is subject to ground conditions and adequate traction.

Drive speeds

Stowed, maximum 4.0 km/h
12.2 m/10.9 sec

Platform raised, maximum 0.8 km/h
12.2 m/55 sec

Floor loading information

Tire load maximum 395 kg

Tire contact pressure 9.41 kg / cm²
922.84 kPa

Occupied floor pressure 1180 kg / m²
11.57 kPa

Note: Floor loading information is approximate and does not incorporate different option configurations. It should be used only with adequate safety factors.

Continuous improvement of our products is a Genie policy. Product specifications are subject to change without notice or obligation.



Distributed By: